

DESCRIPTION:
GEARMOTOR 22B3BEBL-Z2

SHEET: 1/1
SCALE: 1:1
C
UNLESS OTHERWISE SPECIFIED:
UNITS ARE IN INCHES [mm]
TOLERANCES: .XX:±.01 .XXX:±.005
ANGLES: X°:±3° X.X°:±0.5°

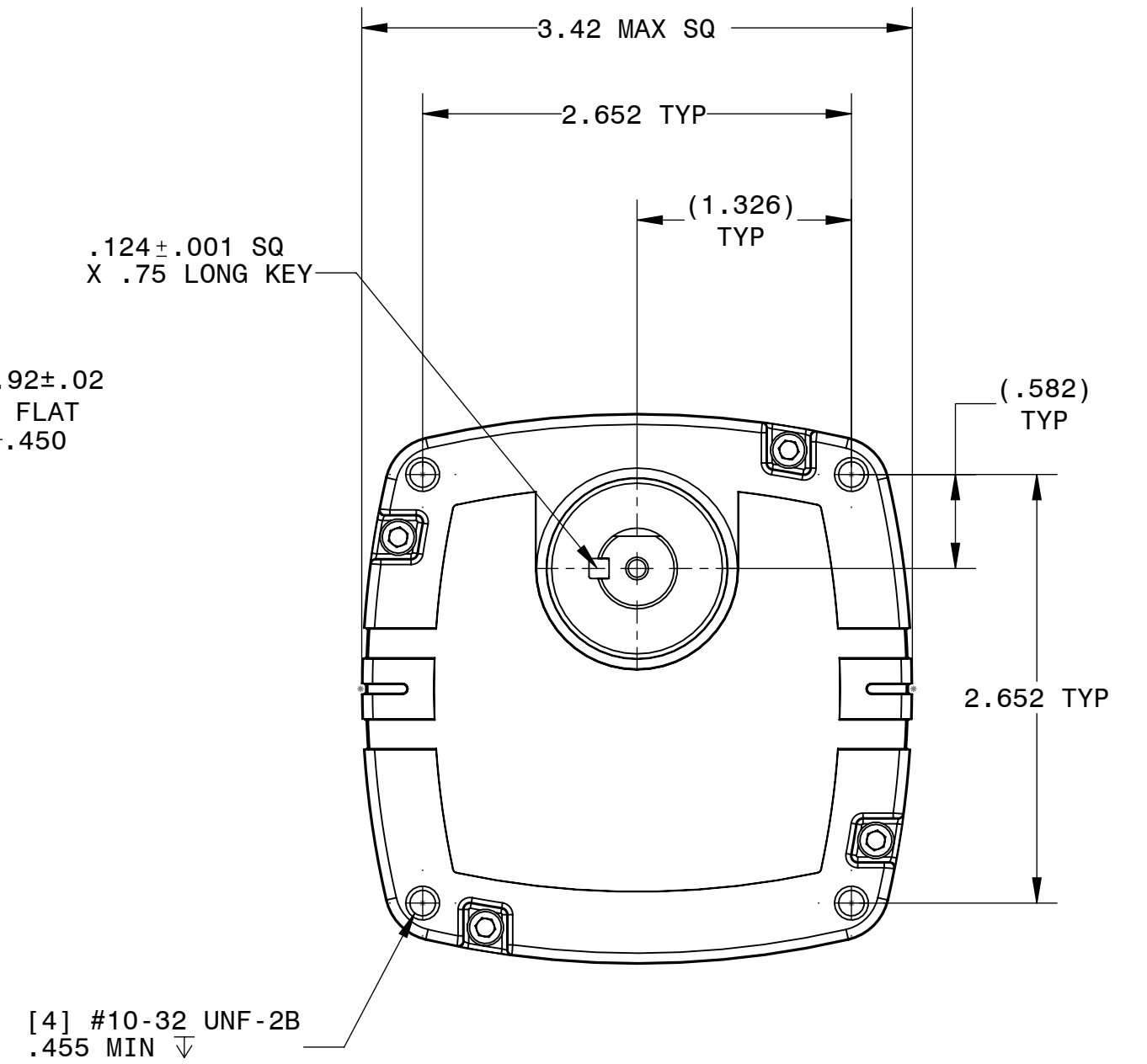

REPRESENTATIVE OF MODEL NUMBER(S):
3557 3558 3559

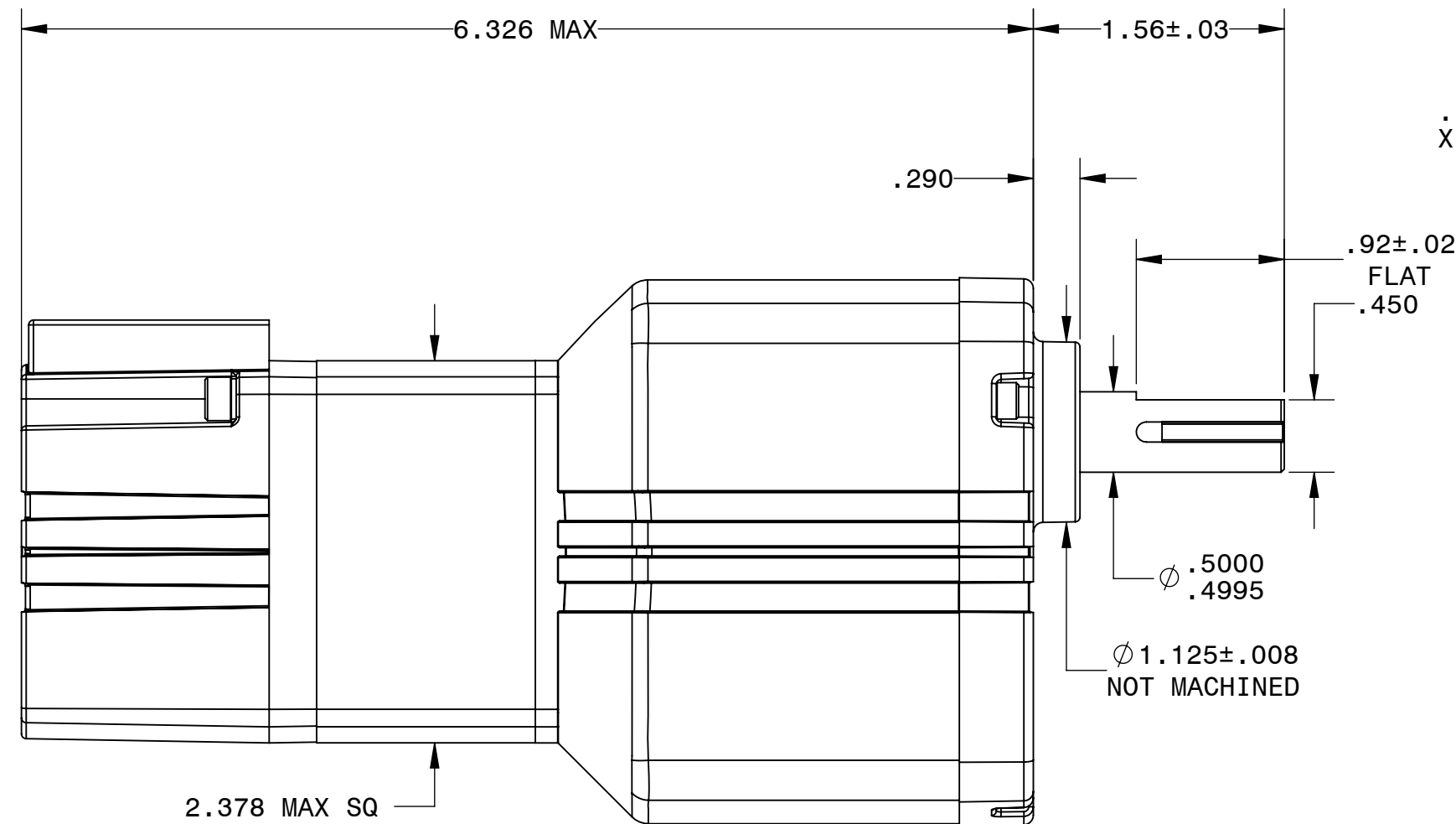
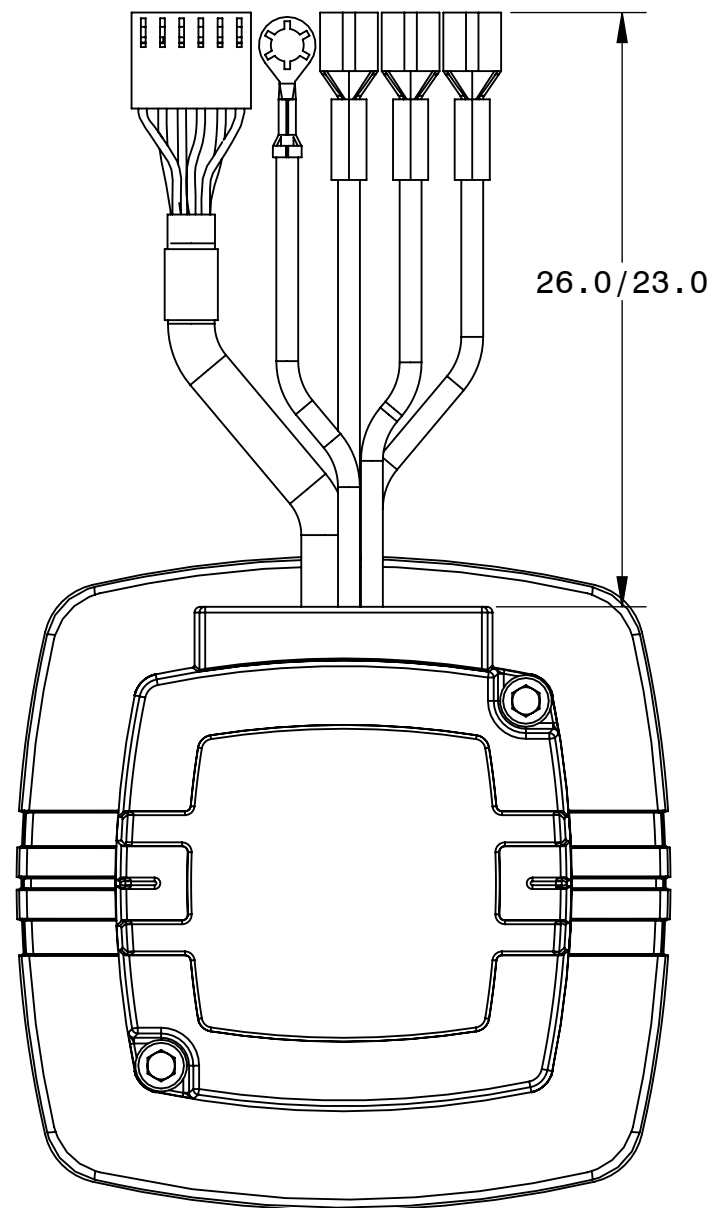