

PESS182TC3M-4

WASHDOWN DUTY MOTOR

NEMA PREMIUM EFFICIENCY

STAINLESS STEEL CONSTRUCTION - C-FLANGE WITH FEET

TOTALLY ENCLOSED FAN COOLED - IP66 CONSTRUCTION

INVERTER DUTY 10:1 CT; 20:1 VT - NEMA MG1 PART 31

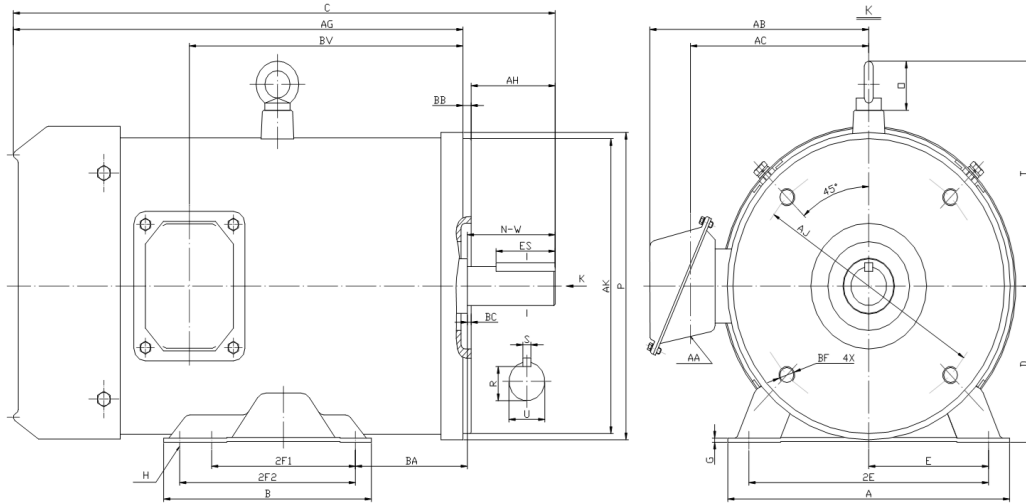

DIMENSIONS

HP	RPM	Frame	Mounting													
			A	B	C	D	G	H	E	2E	2F1	2F2	P	AK	AJ	AH
3	1800	182TC	8.80	6.50	17.00	4.50	0.12	0.71*0.47	3.75	7.50	4.50	5.50	8.85	8.500	7.250	2.62

Mounting				Shaft Extension, Key Set						Conduit Box				Bearings		Mount
AG	BA	BB	BC	BF	U	R	S	ES	N-W	AA	AB	AC	BV	DE	ODE	
14.13	3.50	0.25	0.12	4*1/2-13	1.125	0.986	0.250	1.78	2.75	0.94	7.00	5.30	8.60	6308-2RS	6306-2RS	F1

BEARING LUBRICATION: The bearings come lubricated with Mobil Polyrex EM Polyurea Grease.



PESS182TC3M-4







WASHDOWN DUTY MOTOR
NEMA PREMIUM EFFICIENCY
STAINLESS STEEL CONSTRUCTION - C-FLANGE WITH FEET
TOTALLY ENCLOSED FAN COOLED - IP66 CONSTRUCTION
INVERTER DUTY 10:1 CT; 20:1 VT - NEMA MG1 PART 31

PERFORMANCE DATA

HP	RPM	Frame	Voltage	Frequency (Hz)	Full Load S.F.	Insulation Class	NEMA Design	Slip (%)	NEMA Code	Enclosure Type	IP Rating	Max. Ambient
3	1765	182TC	208-230/460	60	1.15	F	B	1.9	K	TEFC	66	40° C

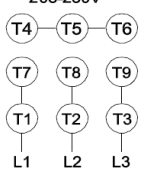
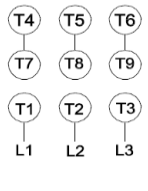
Amps (460V)		Efficiency (%)				Power Factor			Torque (ft-lb)			DE Bearing	ODE Bearing	Connection	Weight (lbs.)
FLA	LRA	100%	75%	50%	Min.	100%	75%	50%	FLT	LRT %	BDT %	6308-2RS	6306-2RS	9 Lead 2Y/Y	78
4.0	32.0	89.5	90.0	89.0	87.5	0.81	0.75	0.64	8.8	270	290				

NAME PLATE

 North American Electric, Inc.															CONNECTION DIAGRAMS 208-230V 		
INVERTER DUTY 20:1 VT; 10:1 CT										WASHDOWN DUTY STAINLESS STEEL MOTORS							
CAT NO: PESS182TC3M-4			FRAME 182TC			PHASE 3											
HZ 60	S.F. 1.15	HZ 50	S.F. 1.0	ENCL TEFC	IP 66	HP 3	RPM 1765	HP 3	RPM 1460	DUTY CONT	DES B						
VOLTS 208-230/460			VOLTS 190/380			AMB 40° C			INS F								
FLA 8.4 - 8 / 4			FLA 9.6/4.8			DE BEARING 6308-2RS											
CODE K		P.F. 0.81	CODE K		P.F. 0.83	ODE BEARING 6306-2RS											
EFF 89.5		MIN 87.5	EFF 87.5		MIN 85.5	LUB: Mobil Polyrex EM											
MOTOR WEIGHT 78 LBS			CONNECTION 9 Lead 2Y/Y			SER NO						460V 					
Special purpose motor designed for washdown applications and extremely corrosive environments. Hernando, Mississippi																	

APPLICATIONS:

Applications include washdown applications, food processing, chemical processing, pharmaceuticals, poultry processing, meat processing, dairy applications, bakeries, snack foods, bottling and extremely corrosive environments.